

**VKA**

**VKAS**

**VKA 355**

Apvalūs kanaliniai ventilatoriai

Circular duct fans

Rohrventilatoren

Круглые каналные вентиляторы

**VKA**

Kanaliniai ventilatoriai, skirti vėdinimo ir oro kondicionavimo sistemoms, montuojami į apvalių ortakių sistemą. Naudojami oro tiekimui ir šalinimui. Nenaudojami užteršto oro, agresyvių, sprogių dujų transportavimui.

Sparnuotė: atgal lenktas sparneliais, plastmasinė arba cinkuoto plieno.

Variklis: išorinis rotorius, tiesioginė pavara, integruota termokontaktinė variklio apsauga, ilgai tarnaujantys nereikalaujantys priežiūros guoliai.

Korpusas: dažytas RAL 7035.

**VKAS**

Kanaliniai ventilatoriai skirti vėdinimo ir oro kondicionavimo sistemoms, montuojami ant sienos. Naudojami oro tiekimui ir šalinimui. Nenaudojami užteršto oro, agresyvių, sprogių dujų transportavimui.

**VKA**

Circular duct fans used for air supply or extract in ventilation and air conditioning systems. Are mounted into a system of round air ducts. Can be installed in any position. Not suitable for polluted air, aggressive and explosive gases.

Impeller with backward curved blades.

Motor: external rotor, motor protection built-in thermal-contact, free-maintenance ball bearings.

Housing: powder coated painting RAL 7035.

**VKAS**

Circular duct fans used for air extract in ventilation and air conditioning systems. Are mounted on the walls. Not suitable for polluted air, aggressive and explosive gases.

**VKA**

Kanalventilatoren, die für Lüftungs- und Klimaanlage bestimmt sind, werden in das System der runden Luftführungs Kanäle montiert. Sie werden für Zuluft und -Abluft verwendet. Nicht geeignet für die Beförderung von verschmutzter Luft, aggressiven, explosiven Gasen.

Laufgrad ist rückwärts gekrümmt, aus Kunststoff oder verzinktem Stahl.

Der Motor: Außenrotor, Direktantrieb, integrierter Thermokontakt-Motorschutz, dauerhafte, keine Pflege erfordernde Lager.

Das Gehäuse: RAL 7035, gestrichen.

**VKAS**

Kanalventilatoren, die für Lüftungs- und Klimaanlage bestimmt sind, werden an die Wand montiert. Sie werden für Zuluft und Abluft verwendet. Nicht geeignet für die Beförderung von verschmutzter Luft, aggressiven, explosiven Gasen.

**VKA**

Канальные вентиляторы для систем вентиляции и кондиционирования, устанавливаются в систему круглых воздуховодов. Эксплуатируются в целях подачи и вытяжки воздуха. Не используются при транспортировке загрязнённого воздуха, агрессивных, взрывоопасных газов.

Крыльчатка: загнутые назад лопатки, пластмасса или оцинкованная сталь.

Двигатель: наружный ротор, прямая передача, встроенная термokonтактная защита двигателя, не требующие ухода подшипники с длительным сроком службы.

Корпус: окрашенный RAL 7035.

**VKAS**

Канальные вентиляторы для систем вентиляции и кондиционирования, настенные. Эксплуатируются в целях подачи и вытяжки воздуха. Не используются при транспортировке загрязнённого воздуха, агрессивных, взрывоопасных газов.

## Accessories

**AP**  
p. 185

**AGO**  
p. 177

**RSK  
SAT**  
p. 167-168

**LAV**  
p. 187

**AKS**  
p. 160

**FD**  
p. 152

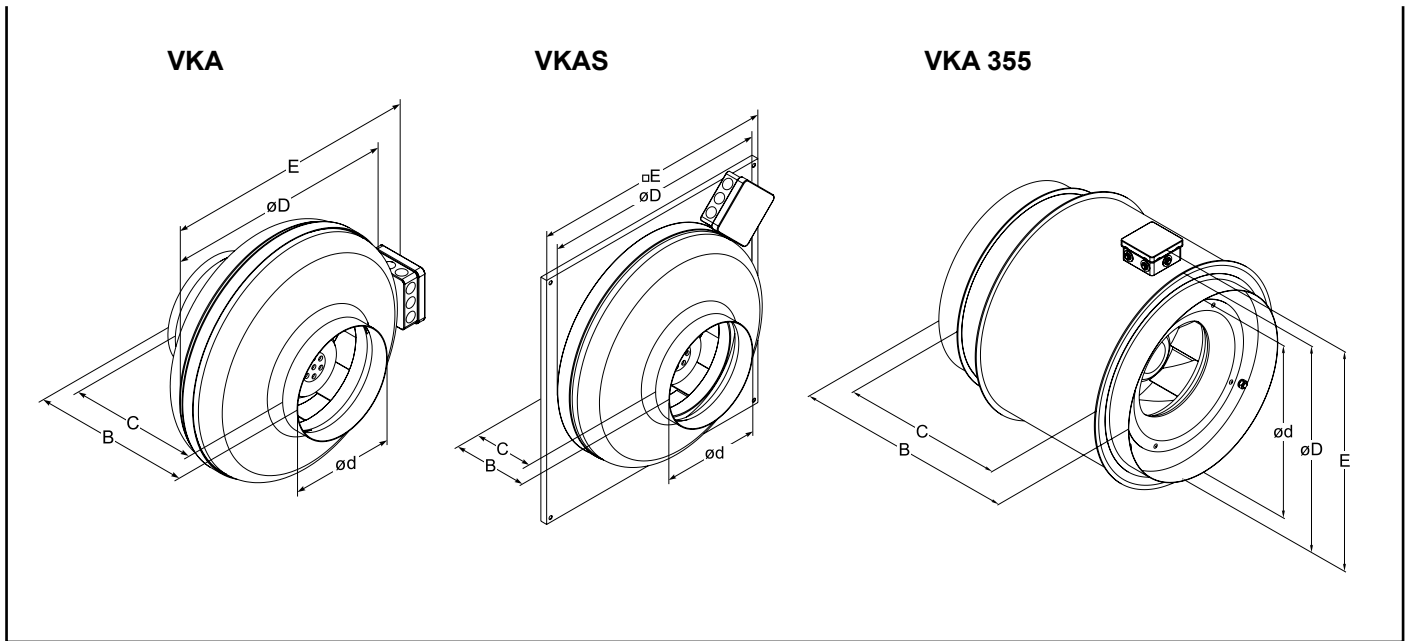

### VKA

Type	Dimensions [mm]				
	B	C	øD	ød	E
VKA 100 MD/LD	206±2	167±2	245	100	287
VKA 125 MD/LD	206±2	175±2	245	125	287
VKA 160 MD	202±2	153±2	245	160	287
VKA 160 LD	227±2	176±2	345	160	389
VKA 200 MD	219±2	167±2	345	200	389
VKA 200 LD	227±2	175±2	345	200	389
VKA 250 MD	223±2	163±2	345	250	389
VKA 250 LD	230±2	170±2	345	250	389
VKA 315 MD	247±2	179±2	402	315	446
VKA 315 LD	257±2	189±2	402	315	446
VKA 355	450	352	420	354	452

### VKAS

Type	Dimensions [mm]				
	B	C	øD	ød	□E
VKAS 100 MD/LD	122	103	242	100	310
VKAS 125 MD/LD	116	101	242	125	310
VKAS 160 MD	116	92	242	160	310
VKAS 160 LD	129	104	342	160	400
VKAS 200 MD	123	99	342	200	400
VKAS 200 LD	131	107	342	200	400
VKAS 250 MD	125	100	342	250	400
VKAS 250 LD	131	106	342	250	400
VKAS 315 MD	156	116	400	315	460
VKAS 315 LD	166	126	400	315	460

### Accessories



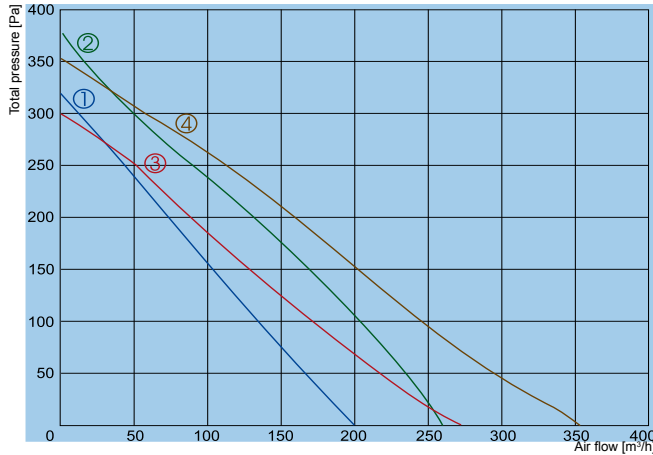

- ① — VKA/VKAS 100 MD
- ② — VKA/VKAS 100 LD
- ③ — VKA/VKAS 125 MD
- ④ — VKA/VKAS 125 LD

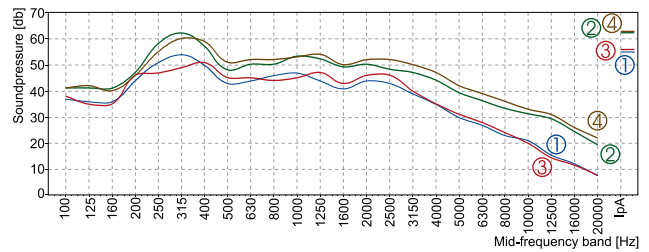

		100 MD	100 LD	125 MD	125 LD
Voltage/Frequency	[V/Hz]	230/50	230/50	230/50	230/50
Power consumption	[W]	34	58	37	58
Current	[A]	0,15	0,26	0,16	0,26
Speed	[min <sup>-1</sup> ]	2500	2500	2500	2500
Max. airflow	[m³/h]	200	260	270	352
Max. air temperature	[°C]	50	50	50	50
Total sound pressure level at 1 m	[dBA]	48	55	49	56
Speed controller		TGRV1,5 / MTY0	TGRV1,5 / MTY0	TGRV1,5 / MTY0	TGRV1,5 / MTY0
Weight	[kg]	3 / 2,5	3 / 2,5	3 / 2,5	3 / 2,5
Wiring diagram		No. 2	No. 1	No. 2	No. 1
<b>Protection class:</b>	motor	IP-44	IP-44	IP-44	IP-44
	terminal box	IP-55	IP-55	IP-55	IP-55

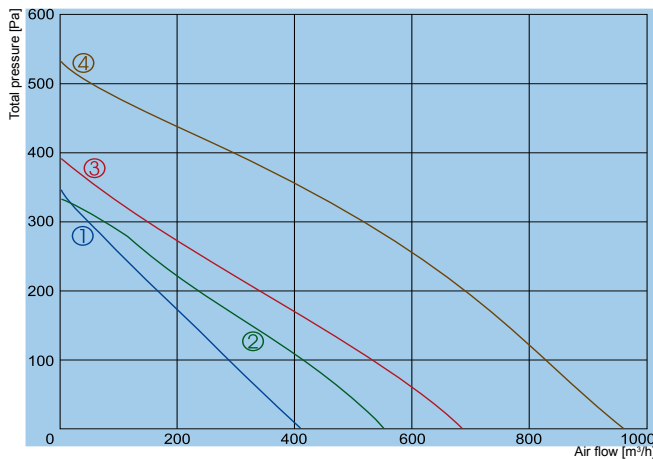

- ① — VKA/VKAS 160 MD
- ② — VKA/VKAS 160 LD
- ③ — VKA/VKAS 200 MD
- ④ — VKA/VKAS 200 LD

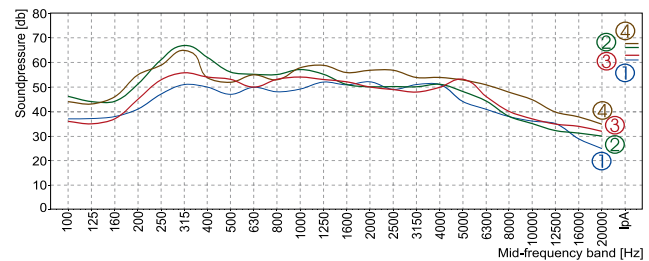

		160 MD	160 LD	200 MD	200 LD
Voltage/Frequency	[V/Hz]	230/50	230/50	230/50	230/50
Power consumption	[W]	58	85	85	135
Current	[A]	0,26	0,38	0,38	0,6
Speed	[min <sup>-1</sup> ]	2500	2600	2600	2650
Max. airflow	[m³/h]	410	555	687	962
Max. air temperature	[°C]	50	40	40	60
Total sound pressure level at 1 m	[dBA]	55	59	56	60
Speed controller		TGRV1,5 / MTY0	TGRV1,5 / MTY0	TGRV1,5 / MTY0	TGRV1,5 / MTY1
Weight	[kg]	3 / 2,8	4	4,5 / 4,1	5 / 4,8
Wiring diagram		No. 1	No. 1	No. 1	No. 1
<b>Protection class:</b>	motor	IP-44	IP-44	IP-44	IP-44
	terminal box	IP-55	IP-55	IP-55	IP-55

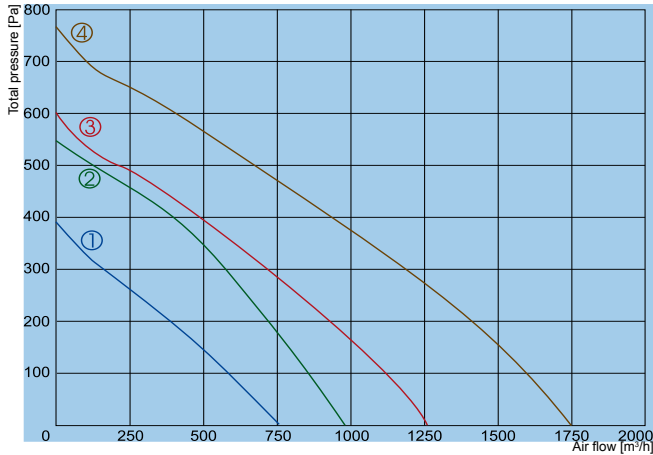

- ① — VKA/VKAS 250 MD
- ② — VKA/VKAS 250 LD
- ③ — VKA/VKAS 315 MD
- ④ — VKA/VKAS 315 LD

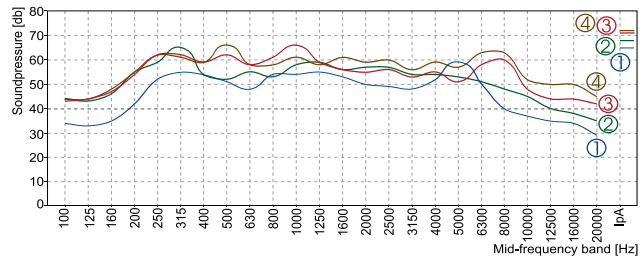

		250 MD	250 LD	315 MD	315 LD
Voltage/Frequency	[V/Hz]	230/50	230/50	230/50	230/50
Power consumption	[W]	85	135	155	225
Current	[A]	0,38	0,6	0,7	1,0
Speed	[min <sup>-1</sup> ]	2600	2650	2600	2700
Max. airflow	[m³/h]	757	986	1260	1753
Max. air temperature	[°C]	40	60	50	40
Total sound pressure level at 1 m	[dBA]	58	61	64	65
Speed controller		TGRV1,5 / MTY0	TGRV1,5 / MTY1	TGRV1,5 / MTY1	TGRV1,5 / MTY2
Weight	[kg]	4,5 / 4,1	5 / 4,9	6,5 / 5,6	6,5 / 6,0
Wiring diagram		No. 1	No. 1	No. 1	No. 1
Protection class:	motor	IP-44	IP-44	IP-44	IP-44
	terminal box	IP-55	IP-55	IP-55	IP-55

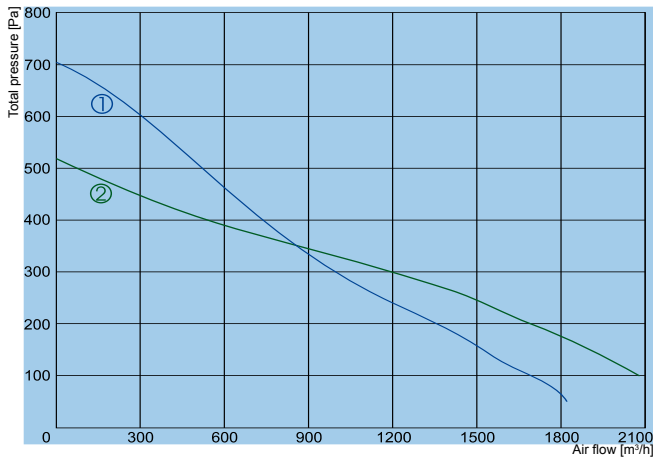

- ① — VKA 355 SD
- ② — VKA 355 MD

		355 SD	355 MD
Voltage/Frequency	[V/Hz]	230/50	230/50
Power consumption	[W]	225	280
Current	[A]	1,0	1,23
Speed	[min <sup>-1</sup> ]	2700	2650
Max. airflow	[m³/h]	1820	2080
Max. air temperature	[°C]	40	50
Total sound pressure level at 1 m	[dBA]	77	76
Speed controller		TGRV1,5 / MTY2	TGRV1,5 / MTY2
Weight	[kg]	11,5	12,0
Wiring diagram		No. 1	No. 1
Protection class:	motor	IP-44	IP-44
	terminal box	IP-55	IP-55

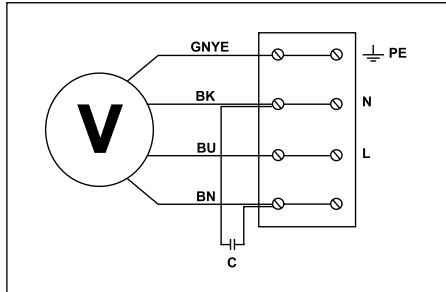

**Wiring diagram No. 1**

GNYE - green-yellow  
 BK - black  
 BU - blue  
 BN - brown

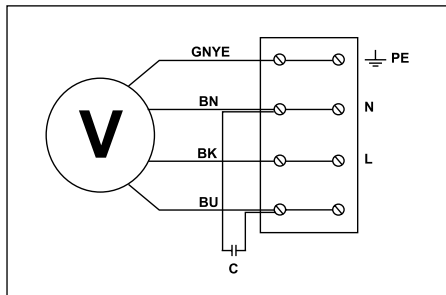

**Wiring diagram No. 2**

GNYE - green-yellow  
 BN - brown  
 BK - black  
 BU - blue

**Note:** this el. diagram is used only for VKA 100 MD, VKA 125 MD fans.

**Note:** Motor insulation class B