



Oro tiekimo agregatai

Air handling units

Lüftungsgeräte

Приточные агрегаты



- Žemas triukšmo lygis
- Reguliuojamo greičio ventiliatorius (įtampos keitimas)
- Elektrinis šildytuvas
- Lengvai nuimamas dangtis patikrinimui
- Filtrų dėžė su EU3 klasės filtru

Oro tiekimo agregatas skirtas oro tiekimui į patalpas. Jis susideda iš kanalinio ventiliatoriaus, kanalinio oro šildytuvo ir filtrų dėžės. Agregatams, kurių šildymo galingumas iki 3,2 kW (~1f) arba 6 kW (~2f), gali būti naudojami elektrinio šildymo reguliatoriai EKR 6, o agregatams, kurių šildymo galingumas virš 6 kW (~3f), gali būti naudojami EKR 15. Visi šie elementai sumontuoti izoliuotame korpuse. Izoliacijos storis 50 mm. Korpusas pagamintas iš cinkuotos skardos su lengvai nuimamu dangčiu. Dangtis tvirtinamas keturiais lengvai atsegamais lankstais.



- Niedriges Geräuschniveau
- Ventilator mit Geschwindigkeitsregelung (Spannungsänderung)
- Elektrische Erwärmungseinrichtung
- Leicht abnehmbarer Deckel für Wartung
- Filterkasten mit dem Filter der EU3-Klasse

Das Zuluft-Aggregat ist für Luftlieferung in Räumlichkeiten bestimmt. Es besteht aus einem Kanalventilator, einer Kanal-Lufterwärmungseinrichtung und einem Filterkasten. Für Aggregate mit einer Erwärmungsleistung bis 3,2 kW (~1f) oder 6 kW (~2f) können Regler der elektrischen Erwärmung EKR 6 verwendet werden, und für Aggregate mit einer Erwärmungsleistung über 6 kW (~3f) können die EKR 15 verwendet werden. Alle diese Elemente sind im isolierten Gehäuse montiert. Isolationsdicke 50 mm. Das Gehäuse ist aus verzinktem Blech mit leicht abnehmbarem Deckel hergestellt. Der Deckel wird mit vier leicht aufknöpfbaren Scharnieren befestigt.



- Low noise level
- Fans: ~1f with external rotor motor.
- Adjustable voltage fan control
- Electrical heater
- Easily removable inspection cover
- Filter box with an EU3-class panel filter
- Wall insulation is 50mm

Air supply units for ventilation systems. Not designed for functioning in explosive – inclined areas. The unit is designed for the air supply into premises. It consists of a duct fan, a duct air heater and a filter box. Heaters with power capacity up to 3,2kW (~1f) or 6kW (~2f) can be controlled by heating controllers EKR 6. For units with heating capacity over 6 kW (~3f), EKR 15 controllers are suitable. All these elements are installed in an isolated housing. The thickness of the wall insulation is 50 mm. The housing is made of galvanized steel and has an easily removable cover. The cover is attached by four hinges which are easy to unclasp.



- Низкий уровень шума
- Вентилятор с регулировкой скорости (изменение напряжения)
- Электрический нагреватель
- Легко снимаемая крышка для проверки.
- Кассета фильтров с фильтром класса EU3

Агрегат подачи воздуха предназначен для подачи воздуха в помещения. Он состоит из канального вентилятора, канального нагревателя воздуха и кассеты фильтров. Все эти элементы установлены в изолированном корпусе. Толщина изоляции 50 мм. Корпус изготовлен из оцинкованной жести с легко снимаемой крышкой. Крышка крепится легко отстегивающимися шарнирами. Для агрегатов, у которых тепловая мощность до 3,2 kW (~1f) или 6 kW (~2f), могут быть использованы электрические регуляторы тепла EKR 6, а для агрегатов, у которых тепловая мощность свыше 6 kW (~3f), могут использоваться EKR 15.

Accessories



AP
p. 185



RSK
SAT
p. 167-168



AKS
p. 160



FDI
p. 153



TJK
p. 150

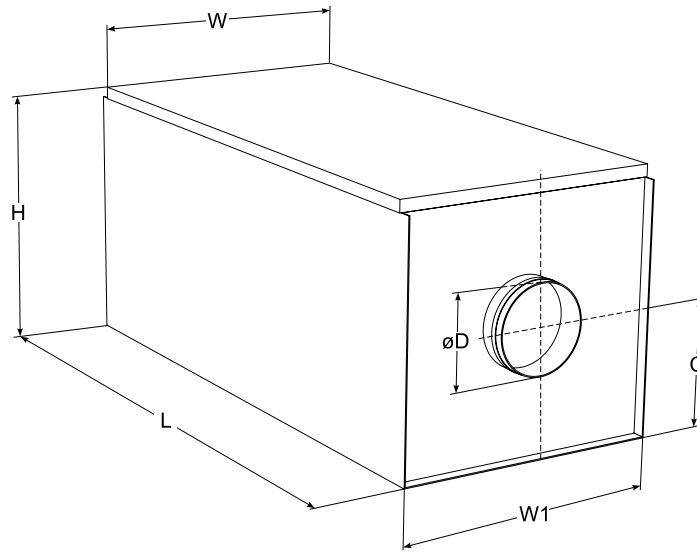

Type	Dimensions [mm]					
	W, mm	W1, mm	C, mm	L, mm	H, mm	øD, mm
OTA 125/1200	490	485	236	1000	490	125
OTA 160/2000	490	485	236	1000	490	160
OTA 160/5000	490	485	236	1000	490	160
OTA 200/2000	490	485	236	1000	490	200
OTA 200/6000	490	485	236	1000	490	200
OTA 250/6000	550	545	285	1050	585	250
OTA 250/9000	550	545	285	1050	585	250
OTA 315/6000	550	545	285	1050	585	315
OTA 315/9000	550	545	285	1050	585	315

Accessories



TGRV
p. 143



MTY
p. 146



EKR
p. 140

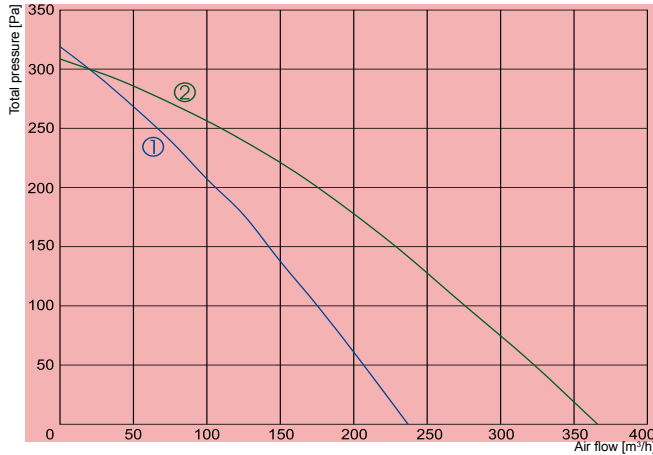

① — OTA 125
② — OTA 160

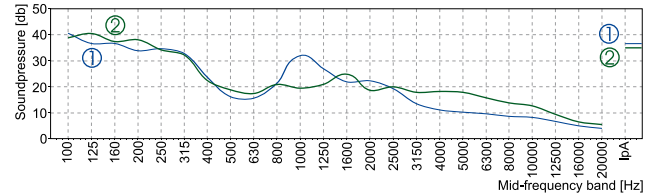

		125/1200	160/2000	160/2400	160/5000	160/6000
Heater	-phase/voltage [50Hz/VAC]	~1, 230	~1, 230	~1, 230	~2, 400	~2, 400
	-power consumption [kW]	1,2	2,0	2,4	5,0	6,0
	-min. air speed [m/s]	1,5	1,5	1,5	1,5	1,5
Fan	-phase/voltage [50Hz/VAC]	~1, 230	~1, 230	~1, 230	~1, 230	~1, 230
	-current [A]	0,26	0,38	0,38	0,38	0,38
	-speed [min ⁻¹]	2500	2600	2600	2600	2600
	-power consumption [kW]	60	85	85	85	85
	-max. airflow [m³/h]	237	366	366	366	366
-motor protection class		IP-44	IP-44	IP-44	IP-44	IP-44
Terminal box protection class		IP-54	IP-54	IP-54	IP-54	IP-54
Filter class		EU3	EU3	EU3	EU3	EU3
Total sound pressure level at 1 m [dBA]		30	28	28	28	28
Wiring diagram		No. 1	No. 1	No. 1	No. 2	No. 2

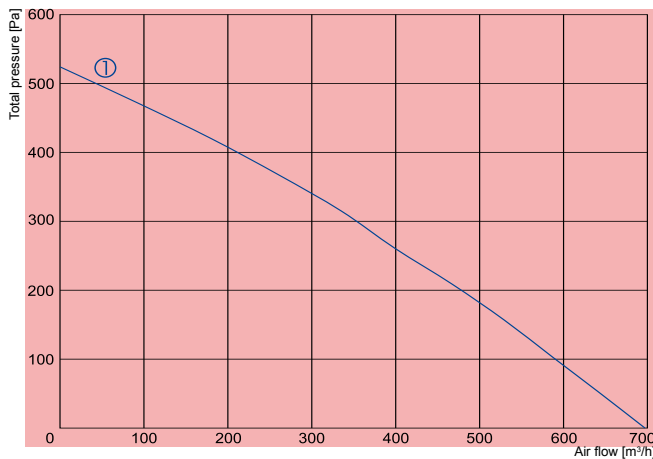

① — OTA 200

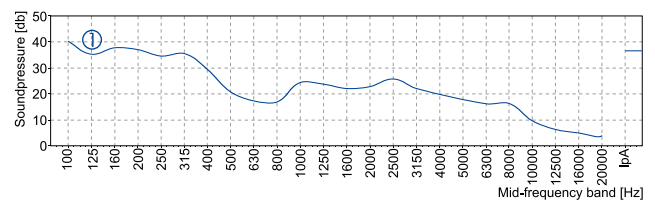

		200/2000	200/2400	200/3000	200/5000	200/6000
Heater	-phase/voltage [50Hz/VAC]	~1, 230	~1, 230	~2, 400	~2, 400	~2, 400
	-power consumption [kW]	2,0	2,4	3,0	5,0	6,0
	-min. air speed [m/s]	1,5	1,5	1,5	1,5	1,5
Fan	-phase/voltage [50Hz/VAC]	~1, 230	~1, 230	~1, 230	~1, 230	~1, 230
	-current [A]	0,60	0,60	0,60	0,60	0,60
	-speed [min ⁻¹]	2650	2650	2650	2650	2650
	-power consumption [kW]	135	135	135	135	135
	-max. airflow [m³/h]	697	697	697	697	697
-motor protection class		IP-44	IP-44	IP-44	IP-44	IP-44
Terminal box protection class		IP-54	IP-54	IP-54	IP-54	IP-54
Filter class		EU3	EU3	EU3	EU3	EU3
Total sound pressure level at 1 m [dBA]		30	30	30	30	30
Wiring diagram		No. 1	No. 1	No. 2	No. 2	No. 2

The unit characteristic curves were determined in accordance with DIN 24163 resp. ISO 5801. The sound power levels were determined in accordance with DIN 45635 resp. ISO 3744 at a distance of 1 m from the unit.

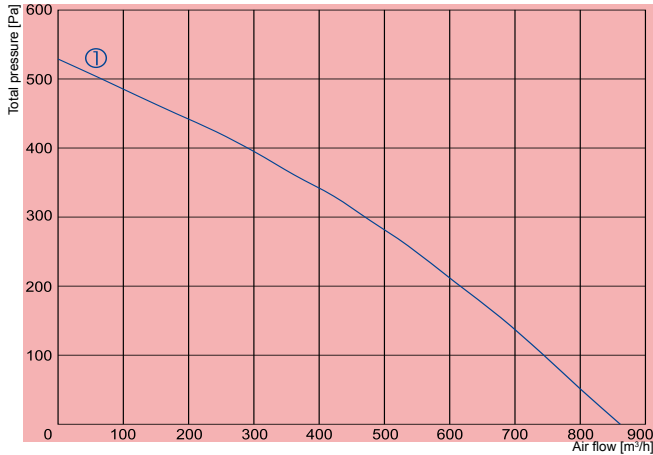

① **OTA 250**

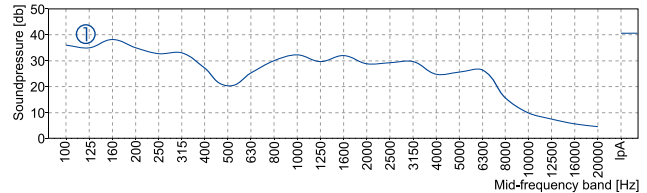

		250/1200	250/5000	250/6000	250/9000
Heater	-phase/voltage [50Hz/VAC]	~1, 230	~2, 400	~2, 400	~3, 400
	-power consumption [kW]	1,0	5,0	6,0	9,0
	-min. air speed [m/s]	1,5	1,5	1,5	1,5
Fan	-phase/voltage [50Hz/VAC]	~1, 230	~1, 230	~1, 230	~1, 230
	-current [A]	0,60	0,60	0,60	0,60
	-speed [min ⁻¹]	2650	2650	2650	2650
	-power consumption [kW]	135	135	135	135
	-max. airflow [m³/h]	960	960	960	960
	-motor protection class	IP-44	IP-44	IP-44	IP-44
Terminal box protection class		IP-54	IP-54	IP-54	IP-54
Filter class		EU3	EU3	EU3	EU3
Total sound pressure level at 1 m	[dBA]	34	34	34	34
Wiring diagram		No. 1	No. 2	No. 2	No. 3

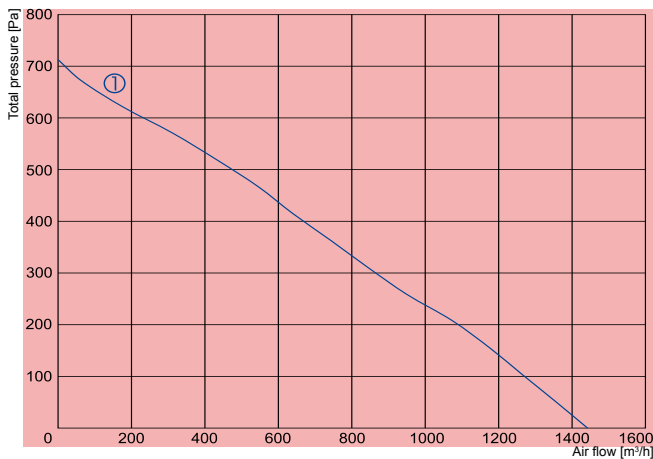

① **OTA 315**

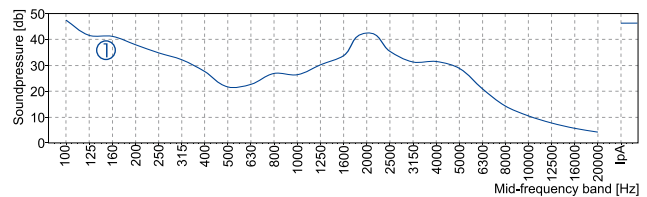

		315/5000	315/6000	315/9000
Heater	-phase/voltage [50Hz/VAC]	~2, 400	~2, 400	~3, 400
	-power consumption [kW]	5,0	6,0	9,0
	-min. air speed [m/s]	1,5	1,5	1,5
Fan	-phase/voltage [50Hz/VAC]	~1, 230	~1, 230	~1, 230
	-current [A]	1,0	1,0	1,0
	-speed [min ⁻¹]	2700	2700	2700
	-power consumption [kW]	225	225	225
	-max. airflow [m³/h]	1442	1442	1442
	-motor protection class	IP-44	IP-44	IP-44
Terminal box protection class		IP-54	IP-54	IP-54
Filter class		EU3	EU3	EU3
Total sound pressure level at 1 m	[dBA]	39	39	39
Wiring diagram		No. 2	No. 2	No. 3

The unit characteristic curves were determined in accordance with DIN 24163 resp. ISO 5801. The sound power levels were determined in accordance with DIN 45635 resp. ISO 3744 at a distance of 1 m from the unit.

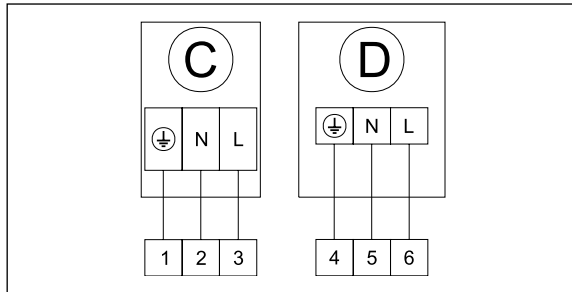

Wiring diagram No. 1

C - Circular fan
D - Electrical heater

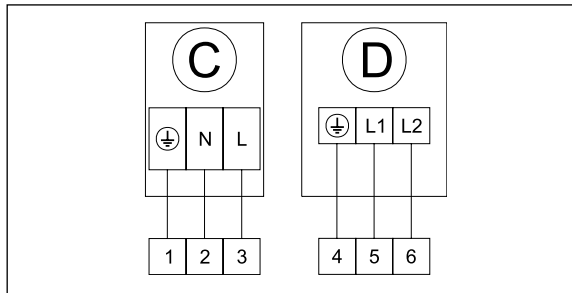

Wiring diagram No. 2

C - Circular fan
D - Electrical heater

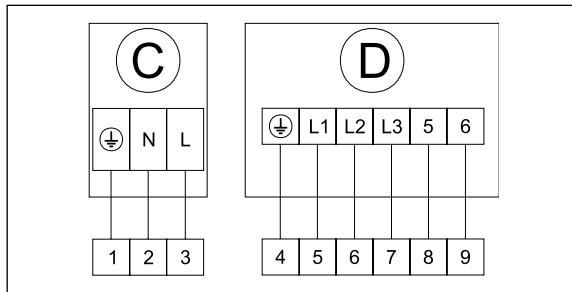

Wiring diagram No. 3

C - Circular fan
D - Electrical heater